

**FOH**  
WORLDWIDE

room360

**FOH**  
FRONT OF THE HOUSE

# The *Ultimate* Buffet Guide

TIPS AND INSPIRATION  
FOR IMPRESSIVE DISPLAYS



**B<sup>3</sup>** Buffet Building Blocks





FOH® is a women-owned, global foodservice and hospitality innovator that includes brands Front of the House® and room360®. Designed in Miami and distributed worldwide, we have created smart, trend-forward, commercial-grade products for over 20 years that deliver a WOW experience. We are culture and collaboration-driven, committed to building lasting relationships with our partners, and this is why our customer loyalty and brand reputation are unmatched.



#### In Stock & Ready to Ship

FOH® is proud to deliver what you need when you need it. From tabletop collections to in-room accessories, our products are in stock and ready to ship from distribution centers worldwide.



#### Product Confidence Guarantee

FOH® creates thousands of products that are intelligently designed, mindfully manufactured, and thoughtfully distributed. We are committed to quality and stand behind our solutions with our Product Confidence Guarantee.



#### Commitment to Sustainability

FOH® is devoted to making a positive impact in the world. From our innovative, award-winning eco-friendly collections to our in-office commitment to sustainability, contributing to the health of the environment is at the heart of our corporate culture.



#### Certified Diverse Supplier

FOH® is founded on the principles of DEI: Diversity, Equity, and Inclusion. Proudly WBENC and NGLCC certified, we are dedicated to empowering one another and cultivating an environment where differences are embraced and celebrated.



## About the Guide

This comprehensive guide offers stylish and practical solutions to create the perfect personalized dining experience for all culinary presentations. Inside, you will find expert planning tips, curated concepts, easy-to-order starter kits, checklists, and more! With our step-by-step guide and creative presentation ideas, you'll be able to effortlessly cater to a variety of tastes and events.

## Table of Contents

<b>Introduction To Buffets</b>	<b>4</b>
The Essentials	
<b>Buffet Building 101</b>	<b>7</b>
<b>STEP 1 - CHOOSE YOUR RISERS</b>	<b>8</b>
Metal & Wireware™ Risers	
Sustainable Risers	
<b>STEP 2 - MATCH YOUR BOARDS</b>	<b>12</b>
Boards Overview	
Perfect Pairings	
<b>STEP 3 - INCLUDE YOUR TEMPERATURE SOLUTIONS</b>	<b>14</b>
Heating & Lighting	
Cooling Solutions & Pans	
<b>STEP 4 - ADD YOUR SERVING ESSENTIALS</b>	<b>16</b>
Serving Essentials	
<b>STEP 5 - OPTIMIZE WITH ACCESSORIES</b>	<b>18</b>
Complementary Accessories	
<b>Curated Concepts &amp; Starter Kits</b>	<b>21</b>
Continental Breakfast	
Ambient Lunch	
Dinner Reception	
Full-Service Bar	
Luxe Grazing Table	
Sweet Bites & Brews	
<b>Pro Tips &amp; The Ultimate Checklist</b>	<b>35</b>
8 Tips to Build a Better Buffet	
Customization	
The Ultimate Checklist	
Storage & Transportation	



# The Essentials

Create an unforgettable buffet experience with the perfect combination of essential elements. Discover the must-have components, including risers, boards, temperature control solutions, and accessories, that will elevate your buffet setup. Get ready to impress your guests with a cohesive and functional display that will leave a lasting impression.

## Risers

Risers come in multiple sizes, shapes, and colors. They nest for easy storage.

## Boards

Architectural glass boards are tempered and have beveled edges. Also available in bamboo.

## Covered Solutions

High-quality covers available in a range of materials and sizes.

## Sign Holders

Call out your culinary creations.

## Cooling Cells & Covers

Provide hours of chilled serving.

## Grill Plates

Grill plates come in 3 shapes and can be used with many risers and housings for hot service.

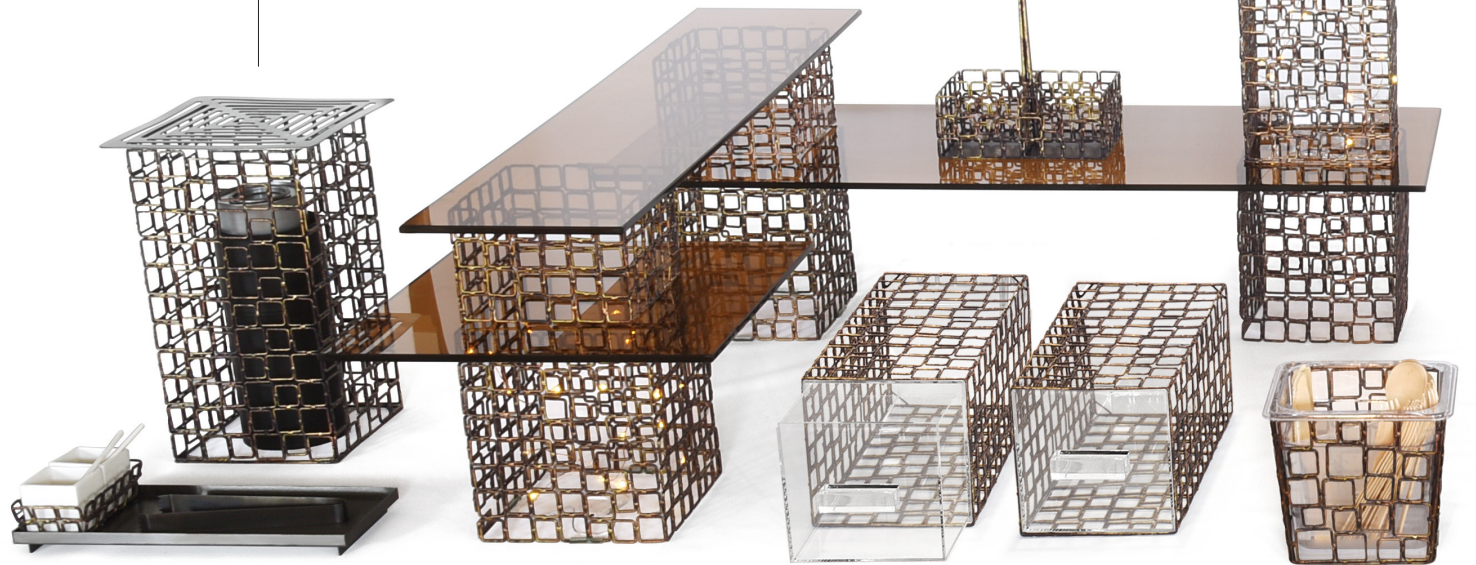

## Utensil Rests

Hundreds of solutions to keep your presentation clean and sanitary.

## Lights

String lights add warmth and ambiance.

## Drawers

Display drawers can house many items and can also double as risers.

## Flatware Dividers

Add a divider to our small housings to organize your flatware.

## Pitchers & Carafes

Drinkwise® durable pitchers and carafes come in 5 sizes. Perfect for salad dressings, juices, cereals, wine, cocktail service, and more.

## Carafe Labels

Our printed labels can be customized to easily identify serving options available.

## Fuel Cell Risers

Stack fuel cell risers for height or use side-by-side as shown.





## Buffet Building 101

---

Create powerful buffet presentations in 5 easy steps by choosing from limitless B<sup>3</sup> Buffet Building Blocks<sup>®</sup> combinations and configurations. Let's get started!

### Steps to Build a Buffet:

1. Choose Your Risers
2. Match Your Boards
3. Include Your Temperature Solutions
4. Add Your Serving Essentials
5. Optimize with Accessories



# Metal & Wireware™ Risers

Our sleek and modern metal and Wireware™ risers serve as the essential building blocks for elevating your buffet presentation, providing multi-dimensional height and depth to enhance the visual appeal of your culinary offerings.

## Dots

- Circular cutouts provide illumination during evening settings when paired with copper string lights
- Powder-coated for durability

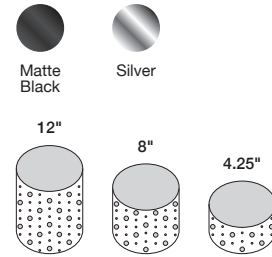

## Zig Zag

- Great for adding multiple levels of buffet boards
- Use vertically as risers and horizontally as drawers

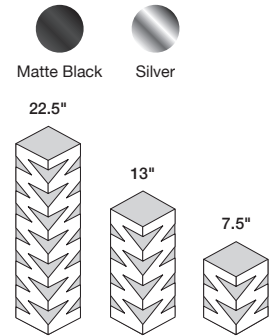

## Twist

- Nest inside one another for easy, compact storage
- Allow for various heights buffet displays

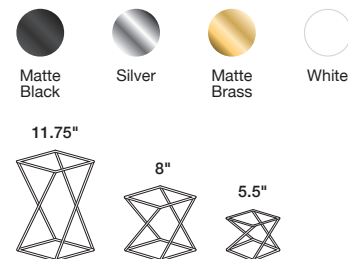

## Universal Metal Housing/Drawer

- Stackable box presentation
- Use vertically as risers and horizontally as drawers

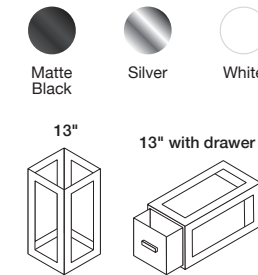

## Coppered Link

- Durable fused hand-painted iron
- Use vertically as risers and horizontally as drawers

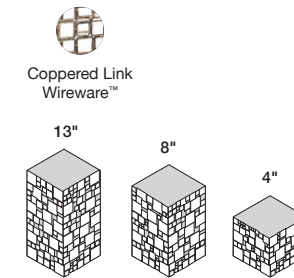

## Patina

- Durable fused hand-painted iron
- Multi-functional shapes and sizes can be used as housings and baskets

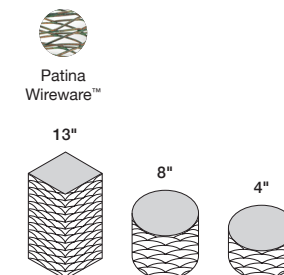



# Sustainable Risers

Crafted from a variety of woods and bamboo, our sustainable risers add warmth and a natural, organic touch to your buffet setups. Mix and match these environmentally friendly pieces for a unique look.

## Asheville Housing/Drawer

- Use vertically as risers and horizontally as drawers
- Stackable box presentation

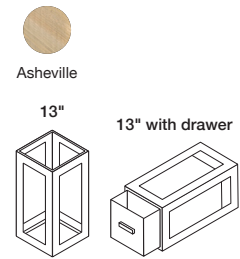

## Asheville Footed Boards

- Create a focal point with elevation
- Nest for easy stacking and storage

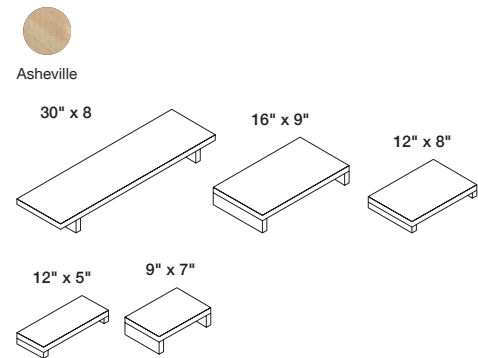

## Asheville Box/Housing

- Use as risers or housings
- Stackable box presentation

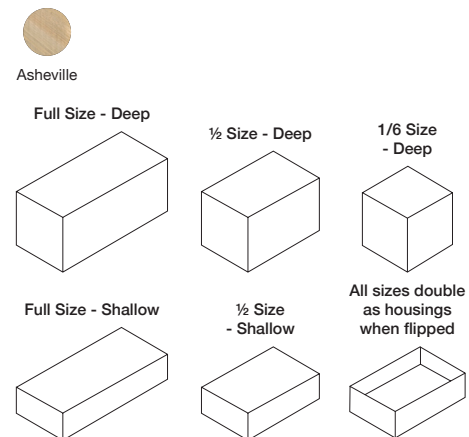

## Bamboo Housing/Drawer

- Use vertically as risers and horizontally as drawers
- Stackable box presentation

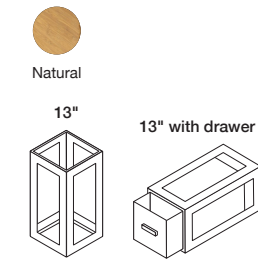

## Bamboo L

- Great for adding multiple levels of buffet boards
- Nest for easy stacking and storage

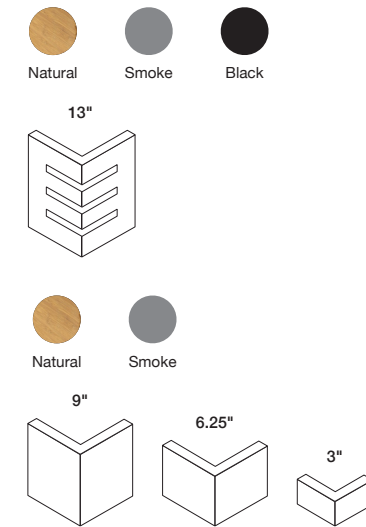

## ROOT™

- Each piece has a unique shape, texture, and grain pattern
- Dense and durable but not heavy

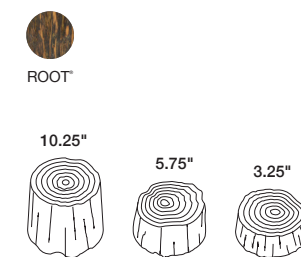



































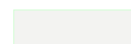

# Boards Overview

This quick diagram gives you a full overview of all our buffet board selections, made from high-quality, tempered glass or durable and sustainable bamboo.

## Available Shapes, Colors & Materials

	Bamboo Natural	Bamboo Smoke	Bamboo Black	Bamboo Mahogany	Tempered Glass Clear	Tempered Glass Smoke	Tempered Glass Amber
14" Square							
19" Square							
14" Circle							
19" Circle							
36" x 8" Rectangle							
36" x 14" Rectangle							
14" Cone Holder							
36" x 8" Cone Holder							

# Perfect Pairings

## Sleek



Twist Matte Black +  
Bamboo Black Boards

## Rustic



Coppered Link Wireware™ + Metroweave® Copper Housing +  
Tempered Glass Amber Boards or Bamboo Mahogany Boards

## Modern



Zig Zag Black Risers or Dots Black Risers +  
String Lights + Tempered Glass Smoke Boards

## Farm-to-table



Twist White + Asheville Boards +  
Tempered Glass Clear Boards or Bamboo Natural Boards

## Casual



Bamboo Slotted Black Risers or  
Bamboo Slotted Smoke Risers  
+ Bamboo Natural Boards

## Industrial



Zig Zag Silver Risers + Twist Silver Risers +  
Tempered Glass Smoke Boards or  
Tempered Glass Clear Boards



# Heating & Lighting

Our portable heating and lighting solutions keep your hot buffet items at the optimal temperature and enhance your displays.

## Grill Plates

Available in 3 sizes:

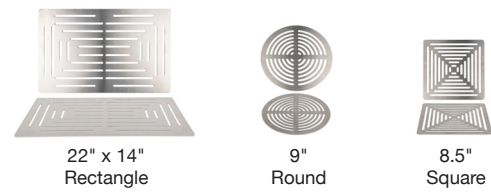

## Fuel Cell Risers

Available in 2 colors:



How To Use:

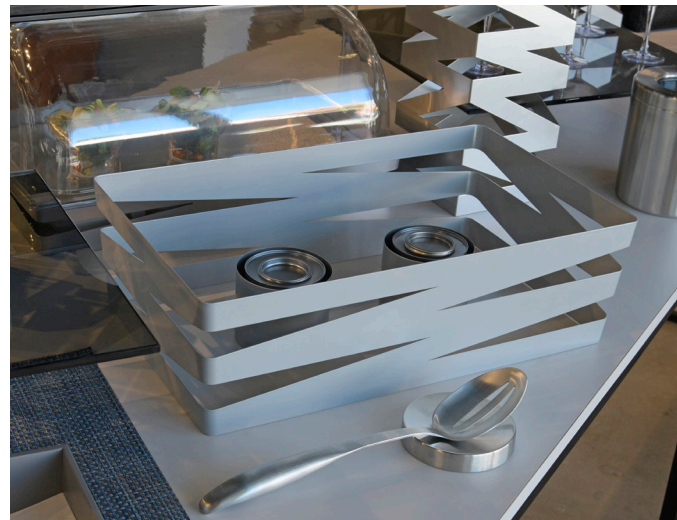
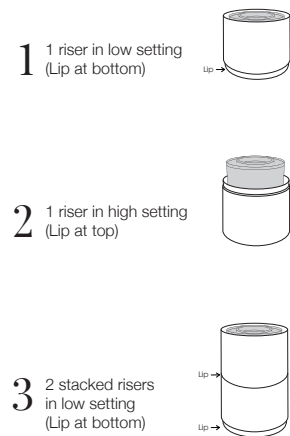

## Copper String Lights

Lights come with batteries that last a minimum of 24 hours.



# Cooling Solutions & Pans

Our lightweight cooling solutions incorporate modular housing components that can be cross-utilized, providing flexibility in both design and purpose. Easy to set up and break down.

## Cooling Cover

Available in 4 sizes:

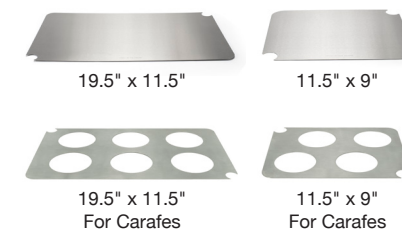

## Cooling Cell

Cooling packs keep items fresh for up to 6 hours and easily fit in various sized pans.

Use 1 cooling cell for 1/2 size pans or 2 cooling cells for full size pans.



How To Use:

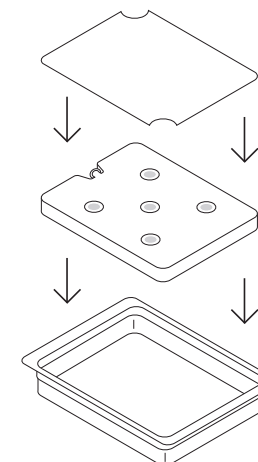

## Pans

Pans are reusable and BPA-free.

Available in 4 sizes:





# Serving Essentials

Maximize your buffet with our innovative, portable, and durable serving solutions. With an array of colors, materials, and functions to choose from, these pieces are sure to add efficiency and practicality to your display.

## Housings

Housings are perfect for serving hot, cold, or dry menu items. Pair them with our pans to create a unique look and make your food transportation easy.

Available in:

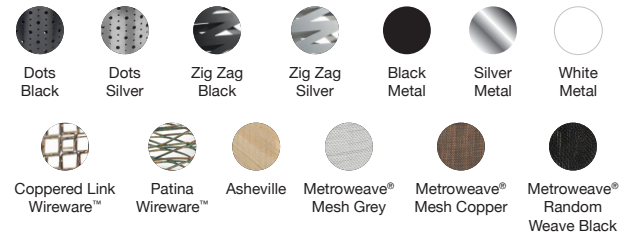

## Drawers

Maximize your investment by using drawers as storage for quick refills, organization, and safety precautions regarding potential allergy risks. Their stackability and durability make for an easy add-on for all displays.

Available in:



## Platters

Platters make for a portable and easy solution when replacing displayed items or serving guests. This ensures that the presentation stays clean and the quality of your food stays fresh.

Available in:

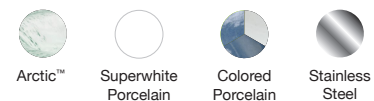

## Trays & Boards

Designed to add convenience, organization, and practicality to your serving solutions, trays and boards are as functional as they are aesthetic. Plus, they allow for easy food transportation, creative displays, and clear navigation of your buffet setting.

Available in:



## Baskets

Baskets offer a flawless solution for organizing condiments, flatware, or snacks, with an extensive range of stylish and creatively designed options available.

Available in:

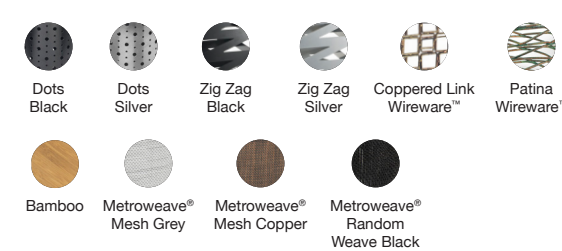

## Covered Solutions

Highlight your signature dishes, while protecting them from contaminants. Our covered solutions keep food fresh and pair well with our housings, pans, platters and trays.

Available in:





# Complementary Accessories

It's all in the details! Complete your buffet presentation with these must-have accessories as the perfect finishing touches. They help orient your guests and contribute to the overall buffet experience.

## Napkin Holders

Placing napkin holders at the beginning and end of your setup ensures guests have easy and quick accessibility when needed. This reduces the traffic around your stations and maintains the flow of your guests.

Available in:

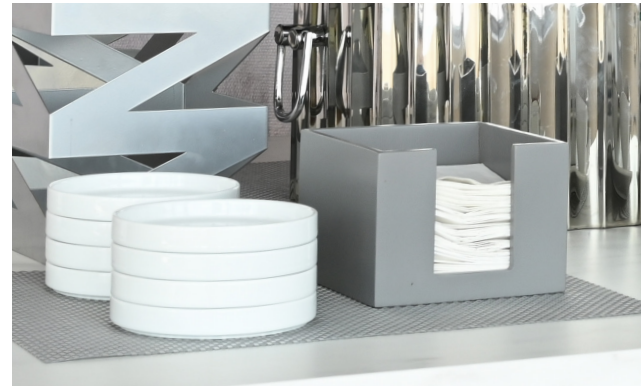

## Menu/Sign Holders

Menu Holders help identify menu options, prevent allergy mishaps, and reassure guests with dietary restrictions.

Available in:



## Serving Utensils

Perfectly ergonomic, our serving utensils were designed for the comfort and reassurance of guests and servers. Made from the highest quality 18/10 stainless steel, these buffet essentials come in a range of functions, sizes, and finishes.

Available in:



## Tongs

Tongs ensure sanitary handling and maximum functionality. Available in unique materials and finishes such as sleek stainless steel, eco-friendly bamboo, and more.

Available in:



## Utensil Rests

The positioning of utensil rests in your display keeps your tabletop clean and easy to navigate. By providing a designated space for your serving utensils and tongs, guests can confidently explore the menu options.

Available in:



## Ramekins

Ramekins are the perfect accessory to present sides, dressings, and condiments to guests for an elevated culinary experience.

Available in:



## Condiment Holders

Our condiment holders allow for a trio of toppings in a centrally located space. Pair them with our condiment spoons for an effective display.

Available in:

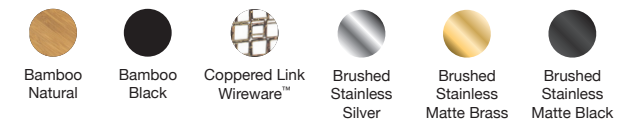

## Woven Vinyl Mats

Our heat-resistant woven vinyl mats are easy-to-clean and keep your tabletops protected. Plus, they can be completely customized to the shape, size, and color you need.

Available in:

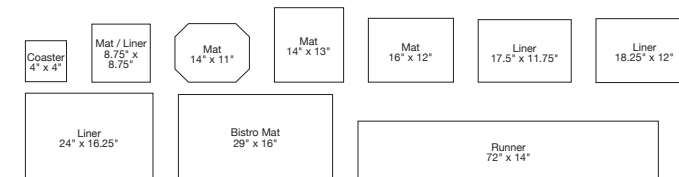





## Curated Concepts & Starter Kits

---

To help you get started, we've curated several buffet starter kits based on popular dining concepts to inspire your presentations. From modern to rustic, sleek to contemporary, B<sup>3</sup> Buffet Building Blocks® provide the versatility and creativity you need to take your displays to the next level.



# Continental Breakfast



## Starter Kit Essentials:

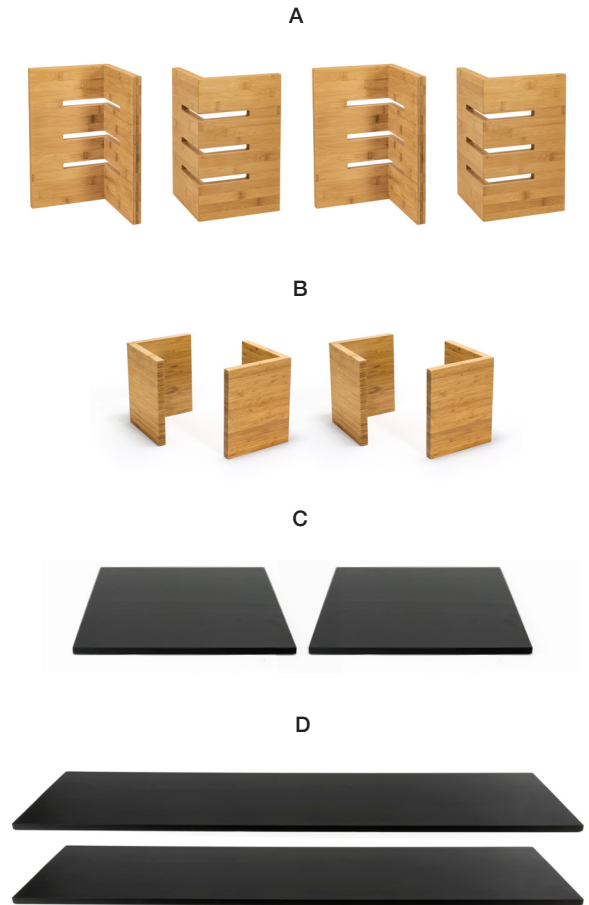

Starter Kit Item Number: **BST051MUM28**  
 Buffet Essentials - Slotted Bamboo - Black Bamboo on Natural Bamboo

Includes Items:		QTY
A	13" Bamboo Slotted L Risers - Set of 2 - Natural	2
B	6.25" Bamboo L Risers - Set of 2 - Natural	2
C	14" Square Bamboo Board - Black	2
D	36" x 8" Bamboo Board - Black	2



Ensure cold dishes stay at optimal temperature with **Cooling Cells and Embedded Covers.**



Up your dressing and beverage service game with **Customizable Carafe Labels.**



Save on ware-washing with **Servewise® Eco-Friendly Disposables.**



# Ambient Lunch



## Starter Kit Essentials:

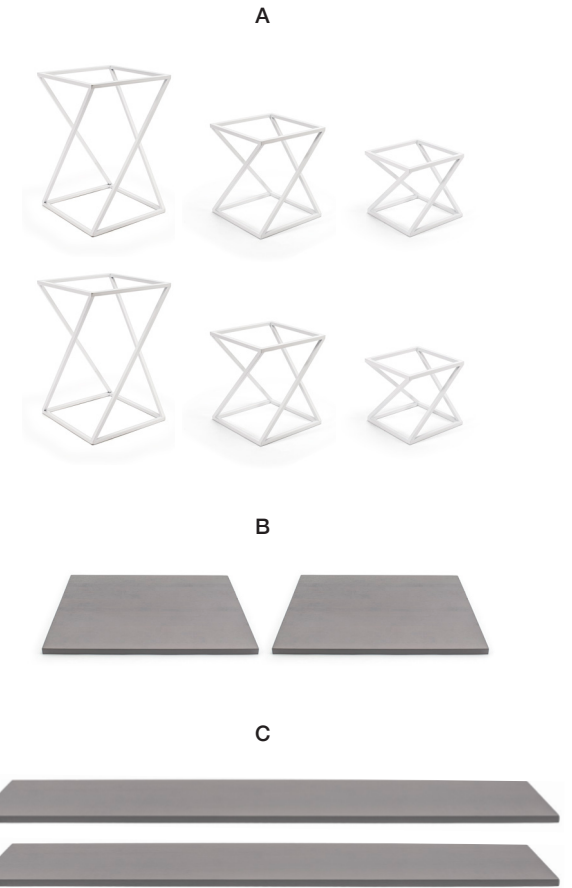

Call out your dishes and ingredients with **Menu Signs and Holders**.



Organize your buffet elements, including utensils, with multipurpose **Metroweave® Baskets**.



Maximize your serving surface and stackability with **Boards**.

Starter Kit Item Number: **BST049MUM28**  
 Buffet Essentials - Twist - Smoke Bamboo on White

Includes Items:		QTY
A	Twist Risers - Set of 3 - White	2
B	14" Square Bamboo Board - Smoke	2
C	36" x 8" Bamboo Board - Smoke	2



# Dinner Reception



## Starter Kit Essentials:

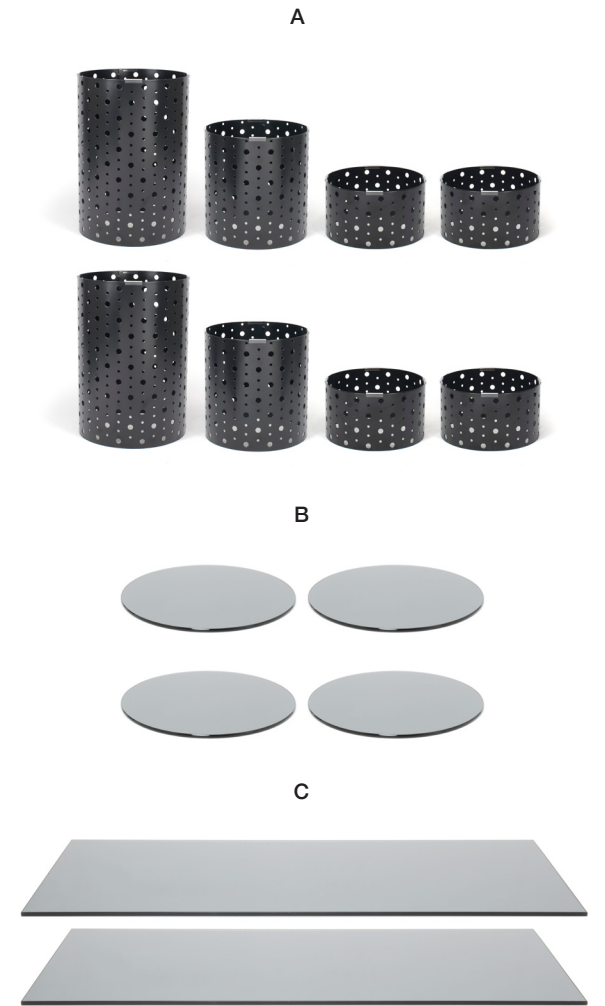

Maintain hot foods at the ideal temperature for hours with **Fuel Cell Risers**.



Add **Utensil Rests** to keep buffet stations and serveware clean.



Protect your buffet tables with **Metroweave® Vinyl Mats**. **BONUS:** They can be customized to your size specifications.

Starter Kit Item Number: **BST024MUM28**  
 Buffet Essentials - Dots - Smoke Glass on Matte Black

Includes Items:		QTY
A	Dots Risers - Set of 4 - Matte Black	2
B	14" Round Tempered Glass Board - Smoke	4
C	36" x 14" Tempered Glass Board - Smoke	2



# Full-Service Bar



## Starter Kit Essentials:

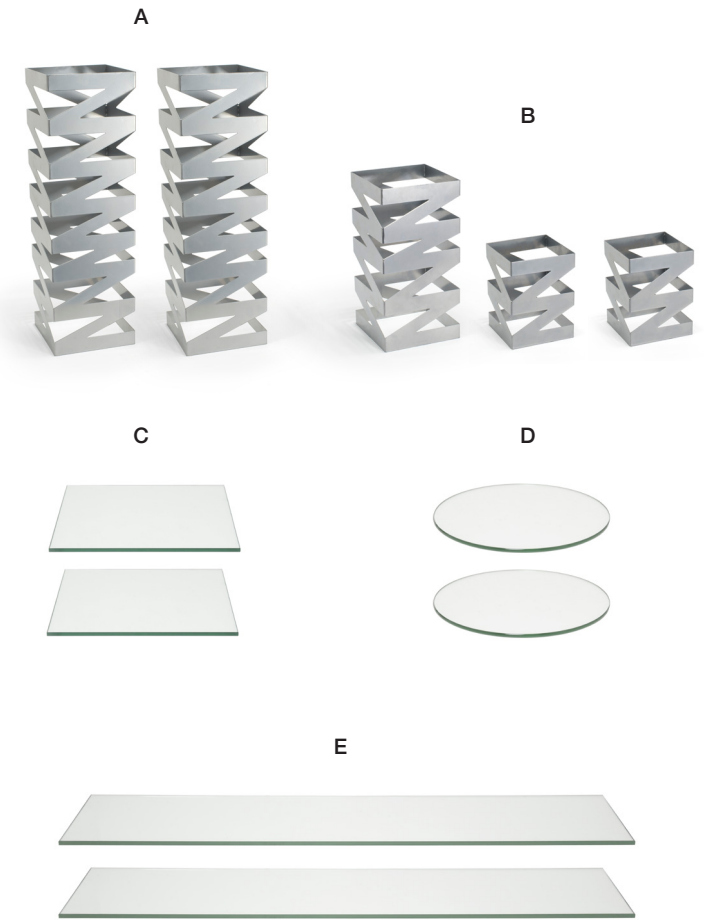

Starter Kit Item Number: **BST016MUM28**  
 Buffet Essentials - Zig Zag - Clear Glass on Silver

Includes Items:		QTY
A	22.5" Zig Zag Risers - Set of 2 - Silver	1
B	Zig Zag Risers - Set of 3 - Silver	1
C	14" Square Tempered Glass Board - Clear	2
D	14" Round Tempered Glass Board - Clear	2
E	36" x 8" Tempered Glass Board - Clear	2



**Tongs** ensure sanitary handling and maximum functionality.



**Stainless Steel Ice Scoop** makes for a stylish and easy-to-use serving solution.



Wow your guests with condensation-free, double-walled, **Stainless Steel Beverage Tubs.**



# Luxe Grazing Table



Scan or click to download the full product list for this concept.



## Starter Kit Essentials:

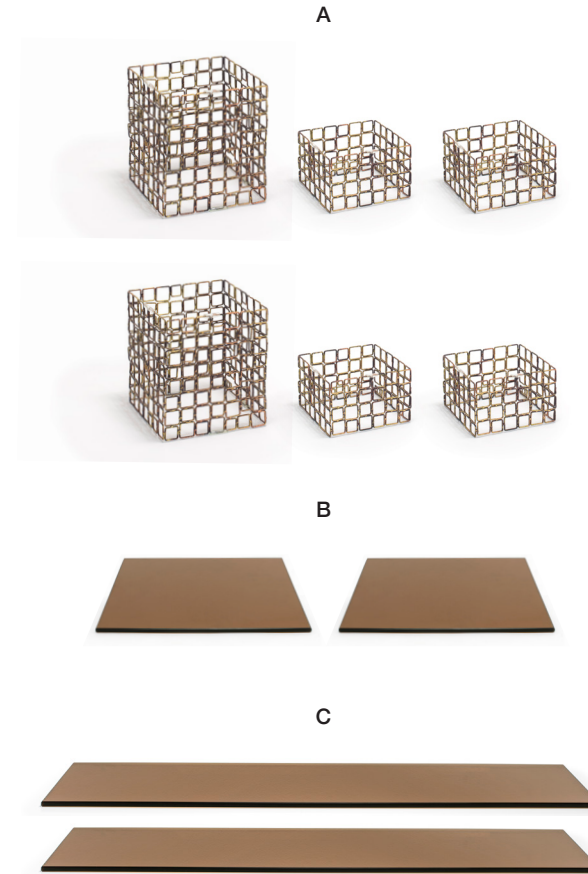

Starter Kit Item Number: **BST039MUM28**  
 Buffet Essentials - Coppered Link - Amber Glass on Coppered

Includes Items:		QTY
A	Coppered Link Risers - Set of 3	2
B	14" Square Tempered Glass Board - Amber	2
C	36" x 8" Tempered Glass Board - Amber	2



Use **Trays and Boards** for convenient mobility when replenishing your display.



Impress your guests with **Statement Pieces** that complement your concept.



**Mix and Match Materials** to add depth to your presentation.



# Sweet Bites & Brews



Scan or click to download the full product list for this concept.



## Starter Kit Essentials:

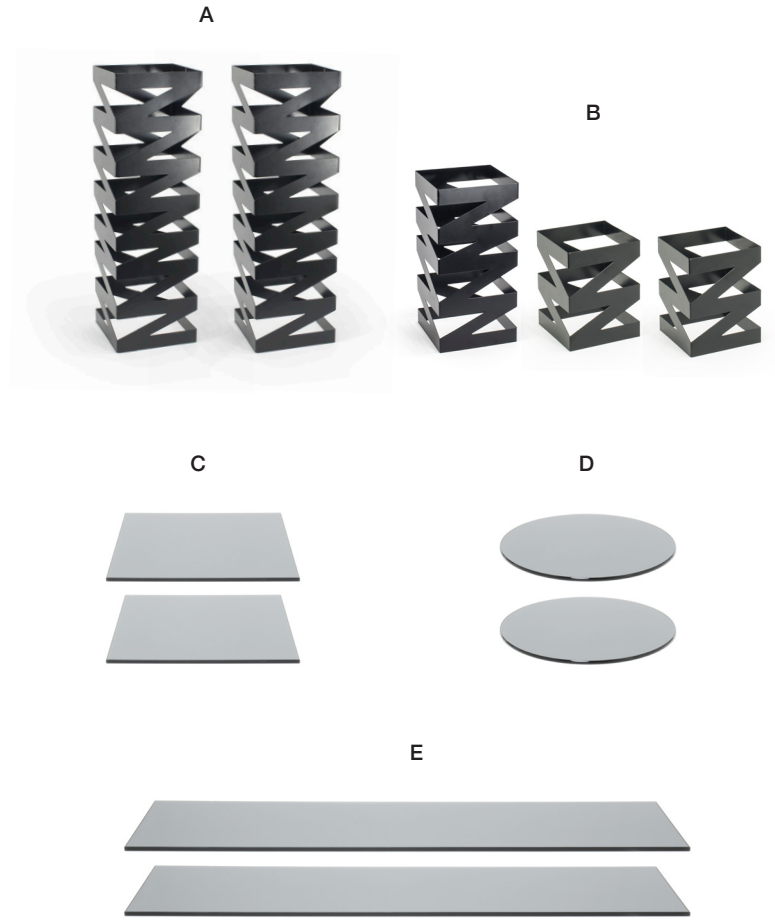

Starter Kit Item Number: **BST011MUM28**  
 Buffet Essentials - Zig Zag - Smoke Glass on Matte Black

Includes Items:		QTY
A	22.5" Zig Zag Risers - Set of 2 - Matte Black	1
B	Zig Zag Risers - Set of 3 - Matte Black	1
C	14" Square Tempered Glass Board - Smoke	2
D	14" Round Tempered Glass Board - Smoke	2
E	36" x 8" Tempered Glass Board - Smoke	2



**Bent Sampler™ Spoons** are easy-to-handle and make for the perfect serving piece in high-volume settings.



Add convenient **Tabletop Waste Bins** for quick clean up and buffet maintenance.



Repurpose **Versatile Risers** as holders or housing to keep your space organized.





## Pro Tips & The Ultimate Checklist

---

Now that you have the basics of B<sup>3</sup> Buffet Building Blocks®, it's time to take it to the next level with expert insights and go-to checklists.



# 8 Tips to Build a Better Buffet

1

## Mix & Match

Our wide range of options allow you to create fabulous looks through a variety of textures, colors, and dimensions. Incorporate different components and materials for an inviting, trend-forward, and dynamic buffet display.

3

## Direct The Flow

Deliver a WOW experience. From stylish menu holders to convenient utensil rests, effortlessly steer your guests and place everything they need right at their fingertips.

5

## Maximize Tabletop Space

Take advantage of our versatile buffet items designed to fulfill multiple purposes. Unleash your creativity and thoughtfulness in discovering various ways to utilize them, maximizing the return on your investment.

7

## Add Accent Colors

Pick colors that accentuate your theme or company colors for an added layer of cohesion. That pop of color will elevate your display, making it more vibrant and memorable.

2

## Don't Fall Flat

Height is your friend! Building up will help you maximize your tabletop real estate while adding dimension to your display. Varying heights can enhance the functionality of your presentation. Plus, this allows your culinary creations to stand out.

4

## Apply Strategic Positioning

Each element of the buffet should seamlessly reside in a purposeful and suitable place. Integrating the right serving vessel or specialized holder adds intentionality and enhances the guest experience.

6

## Keep It Consistent

Your buffet presentation should enhance the room, not clash with it. Consider the colors and materials where your buffet will be placed, ensuring it complements the aesthetics of your environment.

8

## Don't Forget Branding

Emphasize the visual elements of your brand by building a presentation that highlights your logos and colors. This creates brand recognition and is sure to make a lasting impression on your guests.

# Customization

Our extensive custom capabilities include in-house etching and decaling on our wide range of stocked products. Our talented, Miami-based, team of designers will bring your vision to life with their creative expertise. With our quick turnaround times and low minimum quantities, you'll have the flexibility to execute projects of any size, from small accent pieces to a complete custom rollout. Contact your local FOH® representative today to learn more about how we can bring your custom vision to reality.

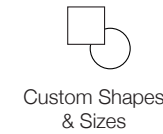

**PRO TIP:** When you discover products you love, save them to your project board to keep your ideas organized and easy to find. Boards can be downloaded or shared with others. Create an account to get started!





# The Ultimate Checklist

## Display Essentials

- |   |   |
|---|---|
| <input type="checkbox"/> Risers         | <input type="checkbox"/> Covers                 |
| <input type="checkbox"/> Boards         | <input type="radio"/> Rolling Covers            |
| <input type="checkbox"/> Housings       | <input type="radio"/> Cloches                   |
| <input type="radio"/> Pans              | <input type="radio"/> Cooling Covers            |
| <input type="radio"/> Flatware Dividers | <input type="checkbox"/> Baskets                |
| <input type="checkbox"/> Drawers        | <input type="radio"/> Basket Liners             |
| <input type="checkbox"/> Utensil Rests  | <input type="checkbox"/> Mats, Liners & Runners |
|   | <input type="checkbox"/> Tabletop Waste Bin     |

## Hot Buffet Essentials

- |   |   |
|---|---|
| <input type="checkbox"/> Grill Plates     | <input type="checkbox"/> Kiln® Ovenware |
| <input type="checkbox"/> Fuel Cell Risers |   |

## Cold Buffet Essentials

- |  |  |
|--|--|
| <input type="checkbox"/> Pans          | <input type="checkbox"/> Cooling Covers - Solid  |
| <input type="checkbox"/> Cooling Cells | <input type="checkbox"/> Cooling Covers - Carafe |

## Beverage Station Essentials

- |   |   |
|---|---|
| <input type="checkbox"/> Ice Buckets        | <input type="checkbox"/> Cooling Covers - Carafe          |
| <input type="checkbox"/> Tongs & Scoops     | <input type="checkbox"/> Gatsby™ Drinkware                |
| <input type="checkbox"/> Beverage Tubs      | <input type="checkbox"/> Porcelain Cups/Mugs              |
| <input type="checkbox"/> Pitchers & Holders | <input type="checkbox"/> Straws                           |
| <input type="checkbox"/> Carafes & Holders  | <input type="checkbox"/> Drinkwise® Unbreakable Drinkware |
| <input type="checkbox"/> Pourers            |   |
| <input type="checkbox"/> Cooling Cells      |   |

## Serving Accessories

- |   |   |
|---|---|
| <input type="checkbox"/> Plates           | <input type="checkbox"/> Flatware         |
| <input type="radio"/> Reusable            | <input type="radio"/> Dinner Fork         |
| <input type="radio"/> Disposable          | <input type="radio"/> Salad Fork          |
| <input type="checkbox"/> Serving Utensils | <input type="radio"/> Dinner Knife        |
| <input type="radio"/> Serving Spoon       | <input type="radio"/> Butter Knife        |
| <input type="radio"/> Slotted Spoon       | <input type="radio"/> Dinner Spoon        |
| <input type="radio"/> Cake Server         | <input type="radio"/> Soup Spoon          |
| <input type="radio"/> Slotted Turner      | <input type="radio"/> Demitasse Spoon     |
| <input type="radio"/> Tongs               | <input type="radio"/> Iced Tea Spoon      |
| <input type="checkbox"/> Picks            | <input type="radio"/> Teaspoon            |
| <input type="checkbox"/> Chopsticks       | <input type="radio"/> Bent Sampler™ Spoon |

## To-Go Essentials

- |   |  |
|---|--|
| <input type="checkbox"/> Servewise® Plates & Covers | <input type="checkbox"/> Servewise® Utensils |
|---|--|

## Storage & Transportation

- |                                     |  |
|-------------------------------------|--|
| <input type="checkbox"/> Duffle Bag | <input type="checkbox"/> Drawstring Bags |
|-------------------------------------|--|

## Finishing Touches

- |  |  |
|--|--|
| <input type="checkbox"/> Menu/Sign Holders | <input type="checkbox"/> Sugar Pack Holders      |
| <input type="checkbox"/> Carafe Labels     | <input type="checkbox"/> Salt & Pepper Shakers   |
| <input type="checkbox"/> Napkin Holders    | <input type="checkbox"/> Mats, Liners, & Runners |
| <input type="checkbox"/> Ramekins          | <input type="checkbox"/> String Lights           |
| <input type="checkbox"/> Condiment Holders |  |

# Storage & Transportation

The perfect buffet transportation and storage solution to organize and protect your buffet essentials.

Contact your local FOH® representative for more information on how you can receive a FREE Buffet Bag!

## Buffet Bag

Drawstring storage bags and safety straps protect your riser and board investments

6 zippered pouches, ideal for utensils, tongs, menu/sign holders, and other small items

Large capacity for holding multiple buffet foundation pieces

Clear front pocket label plus convenient organizational compartments

Strong wheels for reliable transportation and folds flat for easy, compact storage

Front

Back

## Drawstring Storage Bags

**40" x 15" Drawstring Bag**  
Best for our longer boards: 36" x 14" or 36" x 8".

**19" x 15" Drawstring Bag**  
Best for our square or round boards ranging from 14" to 19" in width.



Your worldwide hospitality design and manufacturing partner, dedicated to delivering the WOW experience.

30+ GLOBAL SHOWROOMS | PRODUCTS READY TO SHIP WORLDWIDE



SCHEDULE YOUR SHOWROOM VISIT TODAY

